

No.	Description
AIR SQ2RD 6X6X4	6x6x4 square to round
AIR SQ2RD 6X6X6	6x6x6 square to round
AIR SQ2RD 8X8X6	8x8x6 square to round
AIR SQ2RD 8X8X7	8X8X7 square to round
AIR SQ2RD 8X8X8	8x8x8 Square to Round
AIR SQ2RD 9X9X6	9X9X6 square to round
AIR SQ2RD 9X9X7	9X9X7 square to round
AIR SQ2RD 9X9X8	9x9x8 Square to Round
AIR SQ2RD 9X9X9	9X9X9 Square to Round
AIR SQ2RD 10X10X6	10x10x6 square to round
AIR SQ2RD 10X10X7	10x10x7 square to round
AIR SQ2RD 10X10X8	10x10x8 Square to Round
AIR SQ2RD 10X10X9	10x10x9 Square to Round
AIR SQ2RD 12X12X10	12X12X10 square to rounds
AIR SQ2RD 12X12X12	12x12x12 Square to Round
AIR SQ2RD 12X12X6	12x12x6 Square to Round
AIR SQ2RD 12X12X8	12x12x8 Square to Round
AIR SQ2RD 12X12X9	12X12X9 square to round
AIR SQ2RD 14X14X10	14X14X10 square to round
AIR SQ2RD 14X14X12	14x14x12 Square to Round
AIR SQ2RD 14X14X14	14x14x14 Square to Round
AIR SQ2RD 15X15X10	15X15X10 square to round
AIR SQ2RD 15X15X12	15x15x12 Square to Round
AIR SQ2RD 15X15X14	15x15x14 Square to Round
AIR SQ2RD 18X18X6	18X18X6 square to round
AIR SQ2RD 18X18X8	18X18X8 square to round
AIR SQ2RD 18X18X10	18X18X10 Square to Round
AIR SQ2RD 18X18X12	18X18X12 Square to Round



No.	Description
AIR SQ2RD 18X18X14	18X18X14 Square to Round
AIR SQ2RD 18X18X16	18X18X16 Square to Round
AIR SQ2RD 18X18X18	18x18x18 Square to Round
AIR SQ2RD 20X20X6	20X20X6 square to round
AIR SQ2RD 20X20X12	20X20X12 square to round
AIR SQ2RD 20X20X14	20X20X14 square to round
AIR SQ2RD 20X20X16	20X20X16 square to round
AIR SQ2RD 20X20X18	20X20X18 square to round
AIR SQ2RD 22X22X6	22x22x6 square to round
AIR SQ2RD 22X22X8	22X22X8 square to round
AIR SQ2RD 22X22X10	22X22X10 square to round
AIR SQ2RD 22X22X12	22X22X12 square to round
AIR SQ2RD 22X22X14	22X22X14 square to round
AIR SQ2RD 22X22X16	22x22x16 square to round
AIR SQ2RD 22X22X18	22x22x18 square to round
AIR SQ2RD 22X22X22	22x22x22 square to round

FLX SQ2RD 16X16X14 16X16X14 SQUARE TO ROUND



AIR STRAP 36" Nylon Straps



COK 140 Gemini 140 fan  
 COK 160 Gemini 160 fan  
 COK 180 Ceiling Fan Model 180



COK 220 Ceiling Fan Model 220  
 COK 320 Ceiling Fan Model 320  
 COK 420 Ceiling Fan Model 420  
 COK 520 Ceiling Fan Model 520  
 COK 620 Ceiling Fan Model 620  
 COK 720 Ceiling Fan Model 720  
 COK 820 Ceiling Fan Model 820



No. Description  
 COK ALUM WC 220 alum wall cap for 220-520 fan  
 COK ALUM WC 620 alum wall cap for 620-720 fans



COK FSC 5 AMP 5 amp Solid State Controller  
 COK HANG ISOLATOR Hanging Rubber Isolators

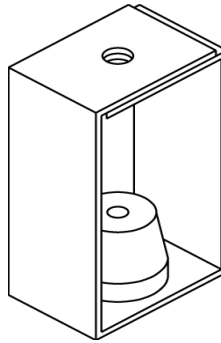

COK PR12 FLAT PR 12 roof cap - flat mount  
 COK PR8 CURB PR 8 roof cap - curb mount  
 COK PR8 FLAT roof vent, flat base PR8



COK RJ 200 Large size Roof Jack  
 COK RJR100 roof jack, 6" round inlet (MP)



COK WC RND 4 4" Round Wall Cap  
 COK WC RND 6 6" Round Wall Cap  
 COK WC RND 8 8" Round Wall Cap

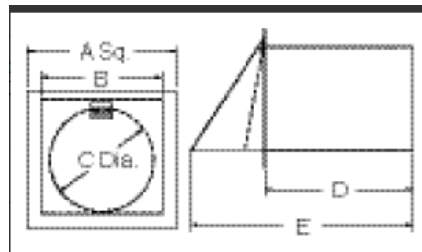

FLX ADC 10X10 Access Door, cam, 10x10  
 FLX ADC 12X12 Access Doors, cam, 12x12  
 FLX ADC 14X14 Access Doors, cam, 14x14  
 FLX ADC 16X16 Access Doors, cam, 16x16  
 FLX ADC 18X18 Access Doors, cam, 18x18  
 FLX ADC 24X24 Access Doors, cam, 24x24  
 FLX ADC 6X6 Access Doors, cam, 6x6  
 FLX ADC 8X8 Access Doors, cam, 8x8



No.	Description
FLX CB SG 10	10" conical stick-on
FLX CB SG 12	12" conical stick-on
FLX CB SG 14	14" conical stick-on
FLX CB SG 16	16" conical stick-on
FLX CB SG 6	6" conical stick-on
FLX CB SG 8	8" conical stick-on
FLX CBD BO 10	Conical Spin, 10", dmpr, b/o
FLX CBD BO 12	Conical Spin, 12", dmpr, b/o
FLX CBD BO 14	14" Conical spin-in, b/o
FLX CBD BO 16	16" Conical spin-in, b/o
FLX CBD BO 6	6" Conical Spin-in w/ buildout
FLX CBD BO 8	8" Conical Spin in w/ buildout
FLX FLD 10 BO	10" Spin-in with buildout
FLX FLD 12 BO	12" Spin-in with buildout
FLX FLD 14 BO	14" Spin-in with buildout
FLX FLD 15 BO	15" Spin-in with buildout
FLX FLD 16 BO	16" spin-in with buildout
FLX FLD 4	4" spin-in with buildout
FLX FLD 5 BO	5" spin-in with buildout
FLX FLD 6 BO	6" spin-in with buildout
FLX FLD 7 BO	7" spin-in with buildout
FLX FLD 8 BO	8" Spin-in with buildout
FLX FLD 9 BO	9" spin-in with buildout



FLX FLEXRIGHT	FLEXRIGHT ELBOW
FLX REDUCER 10X8	10x8 Reducer
FLX REDUCER 10X9	10x9 Reducer
FLX REDUCER 12X10	12x10 Reducer
FLX REDUCER 12X8	12x8 Reducer
FLX REDUCER 14X10	14X10 Reducer
FLX REDUCER 6X5	6x5 Reducer
FLX REDUCER 7X6	7X6 Reducer
FLX REDUCER 8X6	8x6 Reducer
FLX REDUCER 8X7	8x7 Reducer
FLX REDUCER 9X8	9X8 Reducer

FLX SS CLAMP 10	SS Clamp for 10" diameter
FLX SS CLAMP 12	SS Clamp for 12" diameter
FLX SS CLAMP 14	SS Clamp for 14" diameter
FLX SS CLAMP 16	SS Clamp for 16" diameter
FLX SS CLAMP 6	SS Clamp for 6" diameter
FLX SS CLAMP 8	SS Clamp for 8" diameter



FLX STOD BO 10	10" Takeoff with buildout
FLX STOD BO 12	12" Takeoff with buildout
FLX STOD BO 14	14" Takeoff with buildout
FLX STOD BO 16	16" Takeoff with buildout
FLX STOD BO 20	20" Takeoff with buildout
FLX STOD BO 5	5" Takeoff with buildout
FLX STOD BO 6	6" Takeoff with buildout
FLX STOD BO 7	7" Takeoff with buildout



No.	Description
FLX FLD SOG 10 BO3	10" SOG Spin-in with buildout
FLX FLD SOG 12 BO3	12" SOG Spin-in with buildout
FLX FLD SOG 14 BO3	14" SOG Spin-in with buildout
FLX FLD SOG 16 BO3	16" SOG Spin-in with buildout
FLX FLD SOG 6 BO3	6" SOG Spin-in with buildout
FLX FLD SOG 8 BO3	8" SOG Spin-in with buildout
FLX FLDE BO 10	FLDE BO3 10"
FLX FLDE BO 8	FLDE BO3 8"

No.	Description
FLX STOD BO 8	8" Takeoff with buildout
FLX STOD BO 9	9" Takeoff with buildout

No.	Description
FLX TYPE 1M 10	10" Type 1M flex
FLX TYPE 1M 12	12" Type 1M flex
FLX TYPE 1M 14	14" Type 1M flex
FLX TYPE 1M 16	16" Type 1M flex
FLX TYPE 1M 6	6" Type 1M flex
FLX TYPE 1M 7	7" type 1M flex
FLX TYPE 1M 8	8" Type 1M flex
FLX TYPE 1M 9	9" type 1M flex
FLX TYPE 1M R8 10	10" type 1M R8 flex duct
FLX TYPE 1M R8 12	12" type 1M R8 flex duct
FLX TYPE 1M R8 14	14" type 1M R8 flex duct
FLX TYPE 1M R8 16	16" type 1M R8 flex duct
FLX TYPE 1M R8 6	6" type 1M R8 flex duct
FLX TYPE 1M R8 8	8" type 1M R8 flex duct

### Type 1 - Acoustical Flex

**Core:** Polyethylene Fabric (PE)  
**Pressure Rated:**  
 10" w.g. positive  
 5" w.g. negative thru 16" dia.  
 1" w.g. negative, 18" & 20" dia.



Type 1NI  
Connector  
Rated



Type 1B  
Connector  
Rated



Type 1M  
Duct  
Rated

FLX TYPE 3M 10	10" Type 3M flex
FLX TYPE 3M 12	12" Type 3M flex
FLX TYPE 3M 14	14" Type 3M flex
FLX TYPE 3M 16	16" Type 3M flex
FLX TYPE 3M 6	6" Type 3M flex
FLX TYPE 3M 7	7" Type 3M flex
FLX TYPE 3M 8	8" Type 3M flex

### Type 3 - High Pressure

**Core:** Trilaminate of Aluminized Polyester, Fiberglass and Polyester  
**Pressure Rated:**  
 20" w.g. positive  
 10" w.g. negative thru 12" dia.  
 5" w.g. negative, 14" & 16" dia.  
 1" w.g. negative, 18" & 20" dia.



Type 3NI  
Connector  
Rated



Type 3B  
Connector  
Rated



Type 3M  
Duct  
Rated

FLX TYPE 4B 10	10" Type 4B flex
FLX TYPE 4B 12	12" Type 4B flex
FLX TYPE 4B 14	14" Type 4B Flex
FLX TYPE 4B 16	16" Type 4B flex
FLX TYPE 4B 6	6" Type 4B flex
FLX TYPE 4B 8	8" Type 4B flex
FLX TYPE 4M 10	10" type 4M flex
FLX TYPE 4M 12	12" Type 4M Flex
FLX TYPE 4M 14	14" Type 4M Flex
FLX TYPE 4M 16	16" Type 4m Flex
FLX TYPE 4M 6	6" Type 4M Flex
FLX TYPE 4M 8	8" Type 4M Flex

### Type 4 - High Pressure

**Core:** PVC Coated Fiberglass  
**Pressure Rated:**  
 25" w.g. positive  
 10" w.g. negative thru 12" dia.  
 5" w.g. negative, 14" & 16" dia.  
 1" w.g. negative, 18" & 20" dia.



Type 4NI  
Connector  
Rated



Type 4B  
Connector  
Rated



Type 4M  
Duct  
Rated

FLX TYPE 6M 10	10" TYPE 6M FLEX
FLX TYPE 6M 12	12" TYPE 6M FLEX
FLX TYPE 6M 14	14" type 6m flex
FLX TYPE 6M 16"	16" type 6m flex
FLX TYPE 6M 4"	4" type 6m flex
FLX TYPE 6M 5"	5" type 6m flex
FLX TYPE 6M 6	6" TYPE 6M FLEX
FLX TYPE 6M 8	8" TYPE 6M FLEX

### Type 6 - Acoustical Flex

**Core:** Spunbond Nylon Fabric  
**Pressure Rated:**  
 6" w.g. positive  
 5" w.g. negative thru 16" dia.  
 1" w.g. negative, 18" & 20" dia.



Type 6B  
Connector  
Rated



Type 6M  
Duct  
Rated

FLX TYPE 9M 10	10" 9M R6 flex
FLX TYPE 9M 12	12" 9M R6 flex
FLX TYPE 9M 14	14" 9M R6 flex
FLX TYPE 9M 6	6" 9M R6 flex
FLX TYPE 9M 8	8" 9M R6 flex

### Type 9 - Low Pressure

**Core:** A Double Lamination of Tough Polyester with Spring Wire Support  
**Pressure Rated:**  
 6" w.g. positive  
 1/2" w.g. negative



Type 9M  
Duct  
Rated



No.	Description
JER TRSI 12X12X10	SIB 12X12X10 side inlet box
JER TRSI 12X12X12	SIB 12X12X12 side inlet box
JER TRSI 12X12X6	SIB 12X12X6 side inlet box
JER TRSI 12X12X8	SIB 12X12X8 side inlet box
JER TRSI 15X15X10	SIB 15X15X10 side inlet box
JER TRSI 15X15X12	SIB 15X15X12 side inlet box
JER TRSI 15X15X14	SIB 15X15X14 side inlet box
JER TRSI 6X6X6	SIB 6X6X6 side inlet box
JER TRSI 9X9X8	SIB 9X9X8 side inlet box

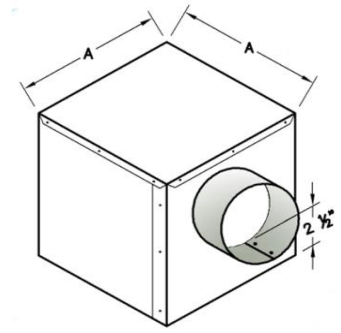

KEL TFORMER 24X24	24v-24v isolation transformer
-------------------	-------------------------------

MIF UA 12X12	sheetrock access panel 12X12
MIF UA 14X14	14X14 sheetrock access panel
MIF UA 14X14 KEY	14x14 sheetrock ADC/W KEY
MIF UA 16X16	sheetrock access panel 16x16
MIF UA 24X24	sheetrock access panel 24x24



RSK 1/2" RND HQ	1/2" ROUND HAND QUAD FOR MD35
RSK 165 B FUSE LINK	165 fuse link, ELSIE, B link
RSK 165 CFD LINK	165 degree fuse link for CFD
RSK 165 FUSE LINK	165 degree fuseable link
RSK 165 FUSE ROD	165 degree fuseable rods
RSK 212 FUSE LINK	212 degree Fuseable link
RSK 285 FUSE LINK	285 degree fuseable link



RSK BEARING LONG	outboard support bearing, long
RSK BEARING SHORT	outboard support bearing short
RSK BLANKET	Mineral Wool Blanket
RSK BUSHING	Brass Bushings for Control Dmp
RSK CFD 12X12	12x12 ceiling fire damper
RSK CFD 15X15	15x15 ceiling fire damper
RSK CFD 18X18	18x18 ceiling fire damper
RSK CFD 22X22	22x22 ceiling fire damper
RSK CFD 6X6	6x6 ceiling fire damper
RSK CFD 9X9	9x9 ceiling fire damper



RSK CFDR 10	10" round ceiling fire damper
RSK CFDR 12	12" round ceiling fire damper
RSK CFDR 14	14" round ceiling fire damper
RSK CFDR 6	6" round ceiling fire damper
RSK CFDR 8	8" round ceiling fire damper



No.	Description
RSK IBD2 10X10	10x10 fire damper
RSK IBD2 12X12	12x12 fire damper
RSK IBD2 14X14	14x14 fire damper
RSK IBD2 6X6	6x6 fire damper
RSK IBD2 8X8	8x8 fire damper



RSK IBD20 10X10	10x10 fire damper w/ sleeve
RSK IBD20 12X12	12X12 fire damper w/ sleeve
RSK IBD20 14X14	14X14 fire damper w/ sleeve
RSK IBD20 6X6	6X6 fire damper w/ sleeve
RSK IBD20 8X8	8X8 fire damper w/ sleeve



STA BULB 16	16" bulbs for residential unit
STA BULB 20	20" bulbs for residential unit
STA RSE 162 10	16" Residential 2 tube 10" cen
STA RSE 162 14	16" Residential 2 tube 14" cen
STA RSE 202 10	20" Residential 2 tube 10" cen
STA RSE 202 14	20" Residential 2 tube 14" cen

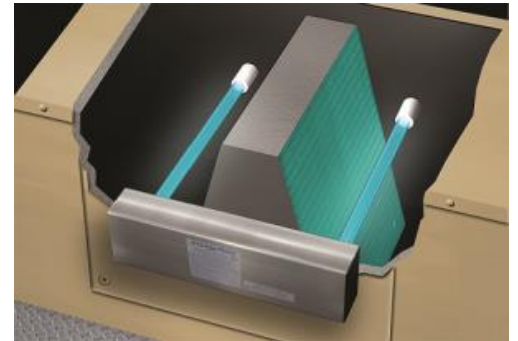

SUN EX128	12x8 Brick Vent
SUN EX164	16x4 Brick Vent
SUN EX168	16x8 Brick Vent
SUN EX808	8x8 Brick Vent



SUN FL 12X12	12x12 Flanged Brick Vent
SUN FL 12X8	12x8 brick vent with flange
SUN FL 16X4	16x4 brick vent with flange
SUN FL 16X8	16x8 brick vent with flange
SUN FL 8X8	8x8 brick vent with flange
SUN FL-808-DB	8x8 flanged bv dark bronze



TSI MOTOR	Electric motor - TSI
TSI RPM20	TSI RPM20 room pressure monitor
TSI TRANSFORMER	120v-24v TSI transformer



No.	Description
TTS 300RS5 6X6	6X6 dbl defl wall grille w/obd
TTS 300RS5 8X6	8x6 dbl defl wall grille w/obd
TTS 300RS5 8X8	8x8 dbl defl wall grille w/obd
TTS 300RS5 10X6	10x6 dbl defl grille w/obd
TTS 300RS5 10X8	10x8 dbl defl grille w/ obd
TTS 300RS5 10X10	10X10 dbl defl grille w/ obd
TTS 300RS5 12X4	12x4 dbl defl grille w/ obd
TTS 300RS5 12X6	12x6 dbl defl grille w/ obd
TTS 300RS5 12X8	12x8 dbl defl grille w/ obd
TTS 300RS5 12X10	12x10 dbl defl grille w/ obd
TTS 300RS5 12X12	12x12 dbl defl grille w/ obd
TTS 300RS5 14X6	14x6 dbl defl grille w/ obd
TTS 300RS5 14X8	14x8 dbl defl grille w/ obd
TTS 300RS5 14X10	14x10 dbl defl grille w/ obd
TTS 300RS5 14X12	14x12 dbl defl grille w/ obd
TTS 300RS5 14X14	14x14 dbl defl grille w/ obd
TTS 300RS5 16X6	16x6 dbl defl grille w/ obd
TTS 300RS5 16X8	16x8 dbl defl grille w/ obd
TTS 300RS5 16X10	16x10 dbl defl grille w/ obd
TTS 300RS5 16X12	16x12 dbl defl grille w/ obd
TTS 300RS5 16X16	16X16 dbl defl grille w/ obd
TTS 300RS5 18X6	18x6 dbl defl grille w/ obd

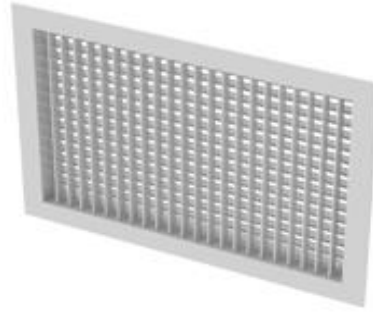

No.	Description
TTS 300RS5 18X8	18x8 dbl defl grille w/ obd
TTS 300RS5 18X10	18x10 dbl defl grille w/ obd
TTS 300RS5 18X12	18x12 dbl defl grille w/ obd
TTS 300RS5 20X6	20x6 dbl defl grille w/ obd
TTS 300RS5 20X8	20x8 dbl defl grille w/ obd
TTS 300RS5 20X10	20x10 dbl defl grille w/ obd
TTS 300RS5 20X12	20x12 dbl defl grille w/ obd
TTS 300RS5 24X6	24x6 dbl defl grille w/ obd
TTS 300RS5 24X8	24x8 dbl defl grille w/ obd
TTS 300RS5 24X10	24x10 dbl defl grille w/ obd
TTS 300RS5 24X12	24x12 dbl defl grille w/ obd

TTS 350RL 8X8	350RL, 8x8, no damper
TTS 350RL 14X14	350RL, 14x14, no damper
TTS 350RL 24X12	350RL, 24x12, no damper
TTS 350RL3 22X22	22x22 layin bar return grille
TTS 350RL5 6X6	6x6 single defl grille w/ obd
TTS 350RL5 8X6	8x6 single defl grille w/ obd
TTS 350RL5 8X8	8x8 single defl grille w/ obd
TTS 350RL5 10X6	10x6 single defl grille w/ obd
TTS 350RL5 10X8	10x8 single defl grille w/ obd
TTS 350RL5 10X10	10x10 sidewall return w/ obd
TTS 350RL5 12X10	12x10 single defl grille w/obd
TTS 350RL5 12X12	12x12 single defl grille w/obd
TTS 350RL5 12X6	12x6 single defl grille w/ obd
TTS 350RL5 12X8	12X8 single defl grille w/obd
TTS 350RL5 14X6	14X6 single defl grille w/obd
TTS 350RL5 14X8	14x8 sidewall return w/ obd
TTS 350RL5 14X10	14x10 single defl grille w/obd
TTS 350RL5 14X14	14x14 single defl grille w/obd
TTS 350RL5 16X6	16x6 single defl grille w/obd
TTS 350RL5 16X8	16x8 single defl grille w/obd
TTS 350RL5 16X12	16x12 single defl grille w/obd
TTS 350RL5 16X16	16x16 single defl grille w/obd
TTS 350RL5 18X10	18x10 single defl grille w/obd
TTS 350RL5 18X12	18x12 single defl grille w/obd



No.	Description
TTS 350RL5 18X14	18x14 single defl grille w/obd
TTS 350RL5 18X18	18X18 single defl grille w/obd
TTS 350RL5 20X12	20x12 single defl grille w/obd
TTS 350RL5 20X16	20x16 single defl grille w/obd
TTS 350RL5 20X20	20x20 single defl grille w/obd
TTS 350RL5 22X22	22x22 single defl grille w/obd
TTS 350RL5 24X12	24x12 single defl grille w/obd
TTS 350RL5 24X16	24x16 single defl grille w/obd
TTS 350RL5 24X18	24x18 single defl grille w/obd
TTS 350RL5 24X24	24x24 single defl grille w/obd
TTS 350RLF3 20X20	350RL layin 20x20 filter rack
TTS 355RL3 12X12	1212 lay-in 355rl, no dmp

No.	Description
TTS 50F1 10X10	10x10 eggcrate surf mnt
TTS 50F1 12X12	12x12 eggcrate surf mnt
TTS 50F1 14X14	14x14 eggcrate surf mnt
TTS 50F1 16X16	16x16 eggcrate surf mnt
TTS 50F1 18X18	18x18 eggcrate surf mnt
TTS 50F1 20X20	20x20 eggcrate surface mount
TTS 50F1 6X6	6x6 eggcrate surf mnt
TTS 50F1 8X8	8x8 eggcrate surf mnt
TTS 50F3 10X10	10x10 neck lay-in eggcrate
TTS 50F3 12X12	12x12 neck lay-in eggcrate
TTS 50F3 14X14	14x14 neck lay-in eggcrate
TTS 50F3 16X16	16x16 neck lay-in eggcrate
TTS 50F3 18X18	18x18 neck lay-in eggcrate
TTS 50F3 20X20	20x20 neck lay-in eggcrate
TTS 50F3 22X10	22X10 neck lay-in, eggcrate
TTS 8RF 20X20	lay-in perforated filter grill

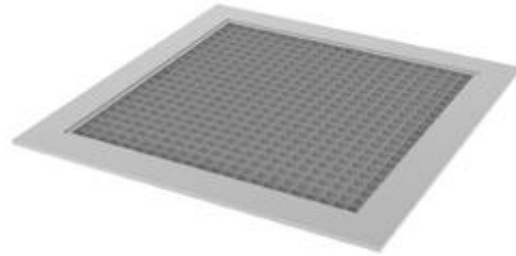

No.	Description
TTS 50F3 22X22	eggcrate grille, layin, 22x22
TTS 50F3 46X22	46x22 eggcrate lay-in
TTS 50F3 6X6	6x6 neck lay-in eggcrate
TTS 50F3 8X8	8x8 neck lay-in eggcrate
TTS 50FF3 20X20	eggcrate filter grille, 20x20



TTS AG15 10X10	damper, AG-15, 10x10
TTS AG15 12X10	12X10 AG15
TTS AG15 12X12	damper, ag-15,12x12
TTS AG15 14X14	damper, ag-15, 14x14
TTS AG15 16X16	damper, ag-15, 16x16
TTS AG15 18X18	damper, ag-15, 18x18
TTS AG15 20X20	damper, ag-15, 20x20
TTS AG15 22X22	damper, AG-15, 22x22
TTS AG15 6X6	damper, AG-15, 6X6
TTS AG15 8X8	damper, ag-15, 8x8



TTS AG95 12X12	damper, ag-95, 12x12
TTS AG95 14X14	damper, ag-95, 14x14
TTS AG95 15X15	damper, ag-95, 15x15
TTS AG95 16X16	damper, ag-95, 16x16
TTS AG95 18X18	damper, ag-95, 18x18
TTS AG95 21X21	damper, AG-95, 21x21
TTS AG95 6X6	damper, ag-95, 6x6
TTS AG95 9X9	damper, ag-95, 9x9



TTS COIL 1R W 10	1rw water coil for 10" box
TTS COIL 1R W 12	1rw water coil for 12" box
TTS COIL 1R W 14	1rw water coil for 14" box
TTS COIL 1R W 16	1rw water coil for 16" box
TTS COIL 1R W 24X16	1 row water coil for 24x16 box
TTS COIL 1R W 6	1rw water coil for 6" box
TTS COIL 1R W 8	1rw water coil for 8" box
TTS COIL 2R W 10	2rw Water Coil for 10" Box
TTS COIL 2R W 12	2rw Water Coil for 12" Box



No.	Description
TTS COIL 2R W 14	2rw Water Coil for 14" Box
TTS COIL 2R W 16	2rw Water Coil for 16" Box
TTS COIL 2R W 6	2rw Water Coil for 6" Box
TTS COIL 2R W 8	2rw Water Coil for 8" Box



No.	Description
TTS D100 10	damper, d-100, 10
TTS D100 12	damper, d-100, 12
TTS D100 14	damper, d-100, 14
TTS D100 6	damper, d-100, 6"
TTS D100 8	damper, d-100, 8
TTS ESV UL 10	10" VAV, w/ control enclosure
TTS ESV UL 12	12" VAV, w/ control enclosure
TTS ESV UL 14	14" VAV,w/ control Enclosure
TTS ESV UL 16	16" ESV, w/ control enclosure
TTS ESV UL 6	6" VAV, w/ control enclosure
TTS ESV UL 8	8" VAV, w/ control enclosure
TTS MOTOR 1/10 277	1/10 hp 277 v motor vav box
TTS MOTOR 1/2 277	1/2 hp 277v motor for fan box
TTS MOTOR 1/3 120	1/3 hp 120v motor for fan box
TTS MOTOR 1/3 277	1/3 hp 277v motor, vav box
TTS MOTOR 1/4 120	1/4 hp 120v motor for fan box
TTS MOTOR 1/4 277	1/4 hp 277v motor, vav box
TTS MOTOR 1/6 120	1/6 hp 120v motor for fan box
TTS MOTOR 1/6 277	1/6 hp 277v motor for fan box
TTS MOTOR 3/4 120	3/4 hp 120v motor for fan box
TTS MOTOR 3/4 277	3/4 hp 277v motor, vav box
TTS OMNI 10	Omni lay-in diffuser, 10" neck
TTS OMNI 12	Omni lay-in diffuser, 12" neck
TTS OMNI 12X12X6	12x12 lay-in, 6" neck Omni
TTS OMNI 12X12X8	12x12 lay-in, 8" neck Omni
TTS OMNI 14	Omni lay-in diffuser, 14" neck
TTS OMNI 6	Omni lay-in diffuser, 6" neck
TTS OMNI 8	Omni lay-in diffuser, 8" neck
TTS OMNI DB	directional baffles for omni
TTS PAR3 22X22	22x22 neck perf lay-in
TTS PAS3 10	10" neck lay-in perf diffuser
TTS PAS3 12	12" neck lay-in perf diffuser
TTS PAS3 14	14" neck lay-in perf diffuser
TTS PAS3 16	16" neck lay-in perf diffuser
TTS PAS3 6	6" neck lay-in perf diffuser
TTS PAS3 8	8" neck lay-in perf diffuser
TTS PASAA3 12"	12" neck aluminum layin perf

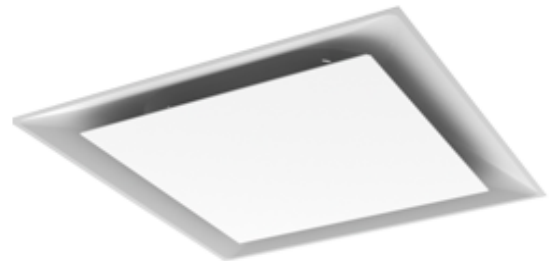

No.	Description
TTS PF 10X10	10x10 Plaster Frame
TTS PF 12X12	12x12 Plaster Frame
TTS PF 14X14	14x14 Plaster Frame
TTS PF 16X16	16x16 Plaster Frame
TTS PF 18X18	18x18 Plaster Frame
TTS PF 20X20	20x20 Plaster Frame
TTS PF 6X6	6x6 Plaster Frame
TTS PF 8X8	8x8 Plaster Frame

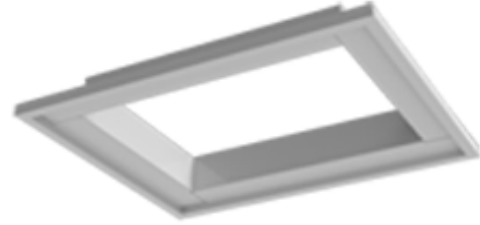

TTS TDC3 12X12	12x12 neck lay-in lvr diffuser
TTS TDC3 12X12 BO	12x12 lay-in TDC diff border
TTS TDC3 12X12X10	10" round neck TDC layin
TTS TDC3 12X12X12	12" round neck TDC layin
TTS TDC3 15X15	15x15 neck lay-in lvr diffuser
TTS TDC3 15X15 BO	15x15 lay-in TDC diff border
TTS TDC3 18X18	18x18 neck lay-in lvr diffuser
TTS TDC3 21X21	21x21 neck lay-in lvr diffuser
TTS TDC3 6X6	6x6 neck lay-in lvr diffuser
TTS TDC3 6X6 BO	6x6 lay-in TDC diff border
TTS TDC3 6X6X6	6" round neck TDC layin
TTS TDC3 9X9	9x9 neck lay-in lvr diffuser
TTS TDC3 9X9 BO	9x9 lay-in TDC diff border
TTS TDC3 9X9X8	8" round neck TDC layin
TTS TDC6 12X12	12x12 neck surf mnt lvr diff
TTS TDC6 12X12 BO	12x12 surf mnt TDC diff border
TTS TDC6 15X15	15x15 neck surf mnt lvr diff



TTS TDCAA3 12X12	Aluminum TDC layin 12x12
TTS TDCAA3 15X15	Aluminum TDC layin 15x15
TTS TDCAA3 18X18	18x18 Aluminum lay-in TDC
TTS TDCAA3 6X6	Aluminum TDC layin 6x6
TTS TDCAA3 9X9	Aluminum TDC layin 9x9
TTS TDCAA6 12X12	Aluminum TDC surf mnt 12x12
TTS TDCAA6 15X15	Aluminum TDC surf mnt 15x15
TTS TDCAA6 6X6	Aluminum TDC surf mnt 6x6
TTS TDCAA6 9X9	Aluminum TDC surf mnt 9x9



TTS TDCCO 12X12 A3	12x12 tdc core a3 blow pattern
TTS TDCCO 12X12 G2	12x12 2 way corner blow core
TTS TDCCO 12X12 S1	12x12 tdc core S1 blow pattern
TTS TDCCO 12X12 S2	12x12 TDC core S2 blow pattern
TTS TDCCO 15X15 A3	TDC 15x15 core A3 blow pattern
TTS TDCCO 15X15 G2	TDC 15x15 core G2 blow pattern
TTS TDCCO 15X15 S1	TDC 15x15 core S1 blow pattern
TTS TDCCO 15X15 S2	TDC 15x15 core S2 blow pattern
TTS TDCCO 18X18 A3	TDC 18x18 core A3 pattern
TTS TDCCO 18X18 S1	TDC 18x18 core S1 pattern
TTS TDCCO 18X18 S2	TDC 18x18 core S2 pattern
TTS TDCCO 6X6 A3	6x6 TDC Core A3 blow pattern
TTS TDCCO 6X6 G2	6x6 2 way corner blow core
TTS TDCCO 6X6 S1	6x6 TDC core S1 blow pattern
TTS TDCCO 6X6 S2	6x6 TDC core S2 blow pattern

No.	Description
TTS TDC6 15X15 BO	15x15 surf mnt TDC diff border
TTS TDC6 18X18	18x18 surf mnt TDC
TTS TDC6 6X6	6x6 neck surf mnt lvr diff
TTS TDC6 6X6 BO	6x6 surf mnt TDC diff border
TTS TDC6 9X9	9x9 neck surf mnt lvr diff
TTS TDC6 9X9 BO	9x9 surf mnt TDC diff border

No.	Description
TTS TDCCO 9X9 A3	9x9 TDC Core A3 blow pattern
TTS TDCCO 9X9 G2	9x9 2 way corner blow core
TTS TDCCO 9X9 S1	9x9 TDC core S1 blow pattern
TTS TDCCO 9X9 S2	9x9 TDC core S2 blow pattern
TTS TFRMR 120-24	115v - 24v transformer
TTS TFRMR 277-24	277v - 24v Transformer

TTS TMS3 10	10" neck lay-in TMS diffuser
TTS TMS3 12	12" neck lay-in TMS diffuser
TTS TMS3 12X12X6	12x12x6 lay-in TMS diffuser
TTS TMS3 12X12X8	12x12x8 lay-in TMS diffuser
TTS TMS3 14	14" neck lay-in TMS diffuser
TTS TMS3 6	6" neck lay-in TMS diffuser
TTS TMS3 8	8" neck lay-in TMS diffuser

TTS TRM 12X12	12x12 TRM Frame
TTS TRM 24X24	24x24 TRM frame

WRD ADC 10	10" round Ward Access door	ADR.jpg
WRD ADC 10X6	10X6 ADC FOR FLAT DUCT	ADR.jpg
WRD ADC 12	12" Round Ward Access Door	ADR.jpg
WRD ADC 14	14" Round Ward Access Door	ADR.jpg
WRD ADC 16	16" round Ward Access door	ADR.jpg
WRD ADC 16X12	16X12 ADC FOR FLAT DUCT	ADR.jpg
WRD ADC 6	6" round Ward access door	ADR.jpg
WRD ADC 8	8" Round Ward Access Door	ADR.jpg

